

AXY - LINE

STOŁY KONFERENCYJNE I OKOLICZNOŚCIOWE

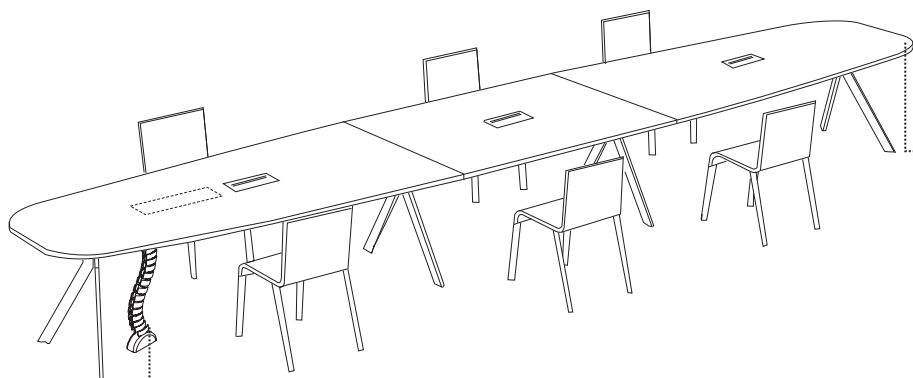

Stoły konferencyjne z modulem wydłużającym

Do wyboru 3 rodzaje podstawy:

- noga A, noga X, noga Y.

Stoły dostępne z 4 kształtami blatów:

- prostokątnym z narożnikami prostymi,
- prostokątnym z narożnikami zaokrąglonymi,
- kształtowym,
- owalnym.

Kanały kablowe

Pionowe i poziome kanały kablowe dopasowane do każdego rodzaju stołu.

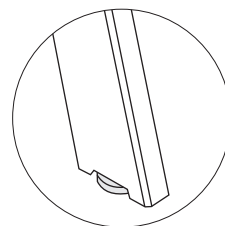
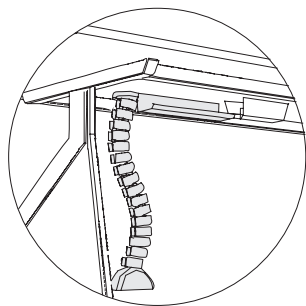

Stopki chromowane

Poziomowanie + 10 mm.

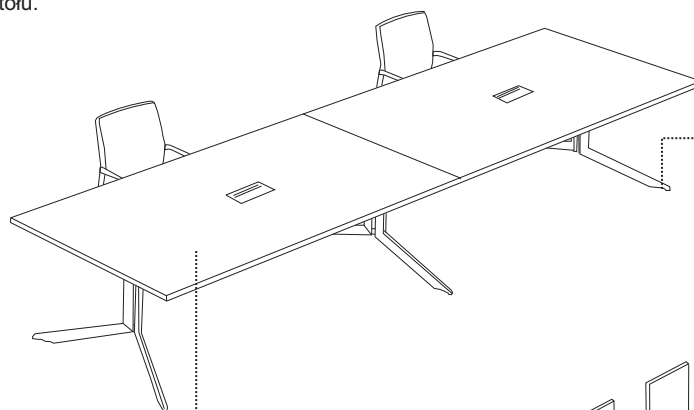

Stoły okolicznościowe

Stoły dostępne w trzech wysokościach stelaża:

- 500 mm,
- 740 mm,
- 1100 mm.

Blat

Grubość 25 mm, wysokiej jakości płyta wiórowa w klasie E1, dwustronnie pokryta melaminą o podwyższonej trwałości. Obrzeże - doklejka z tworzywa sztucznego o grubości 2 mm i promieniu $r = 3$ mm; opcja z dopłatą - aseptyczna doklejka wtapiana laserowo.

Mediaport

Możliwość wyboru modelu i montażu w każdym stole AXY - LINE.

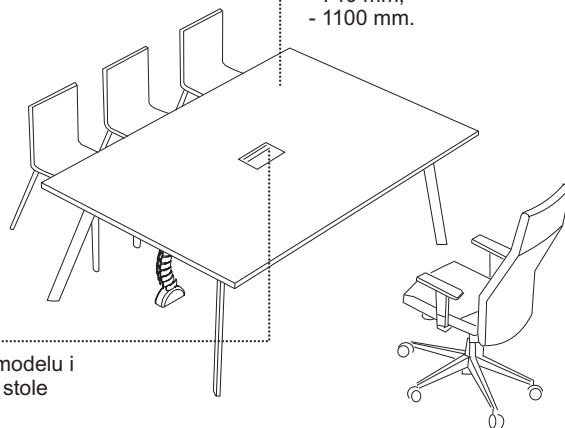

		KOLORYSTYKA	BLAT	NOGI I ELEMENTY METALOWE	STOPKA	Inne kolory płyty z kolekcji: www.PFLEIDERER.com Inne kolory metalu według kolekcji: RAL
PŁYTA	KOLORY GRUPA 1	Biały U1	●	—	—	
		Popiel U2	●	—	—	
		Klon Jasny D7	●	—	—	
		Dąb Napolitano D3	●	—	—	
		Buk D2	●	—	—	
		Czereśnia Havana D1	●	—	—	
		Orzech Maroni D10	●	—	—	
		Grafit U4	●	—	—	
METAL		Chrom	—	—	●	
		Biały M02	—	●	—	
		Aluminium M01	—	●	—	
		Grafit M05	—	●	—	

AXY - LINE

STOŁY KONFERENCYJNE wysokość 740 mm (noga A, X, Y)

Błat prostokątny z narożnikami prostymi

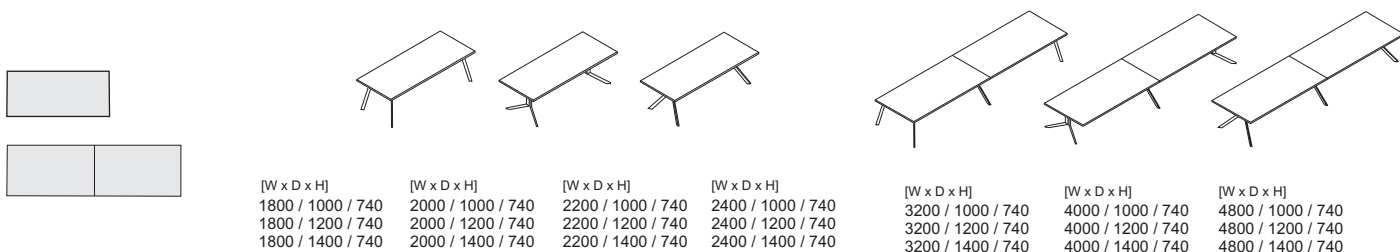

Błat prostokątny z narożnikami zaokrąglonymi

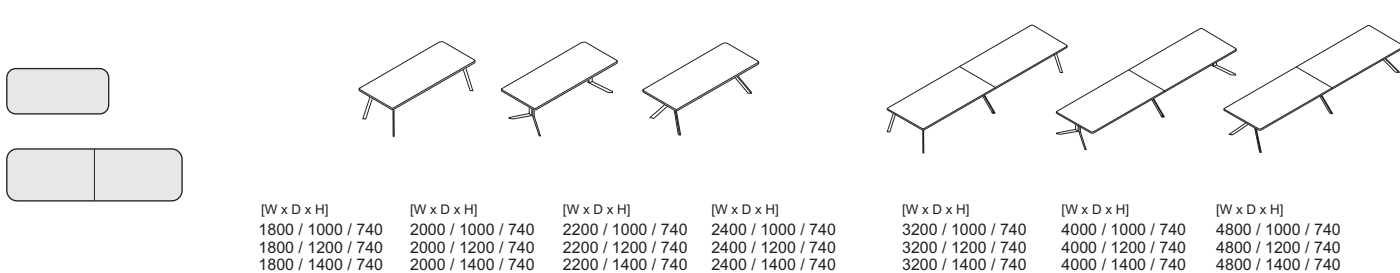

Błat kształtowy

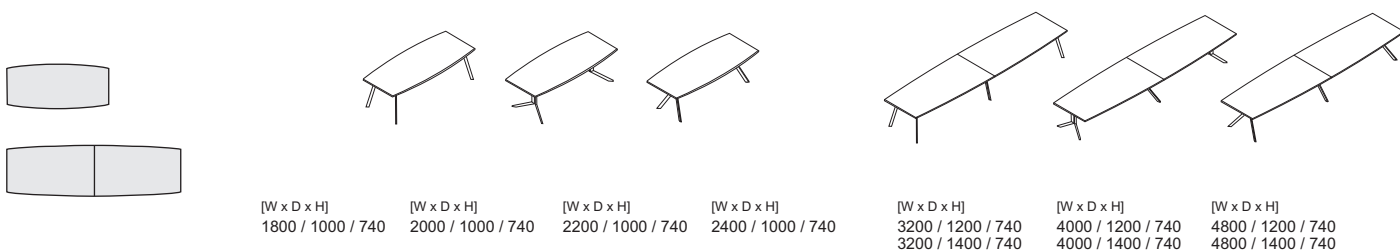

Błat owalny

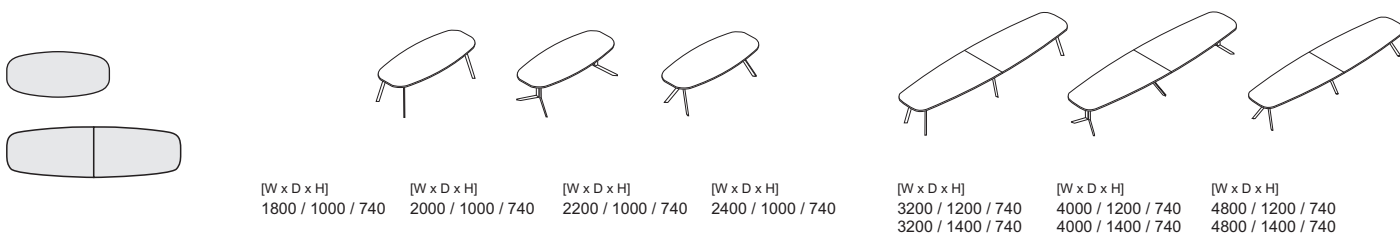

MODUŁ WYDŁUŻAJĄCY DO STOŁÓW KONFERENCYJNYCH

Błat modułu do stołów kształtowych, owalnych i prostokątnych z narożnikami prostymi oraz z narożnikami zaokrąglonymi



AXY - LINE

STOŁY OKOLICZNOŚCIOWE wysokość 740 mm (noga A, X, Y)

Blat kwadratowy z narożnikami prostymi



[W x D x H]
1000 / 1000 / 740

[W x D x H]
1200 / 1200 / 740

[W x D x H]
1400 / 1400 / 740



Blat kwadratowy z zaokrąglonymi narożnikami



[W x D x H]
1000 / 1000 / 740

[W x D x H]
1200 / 1200 / 740

[W x D x H]
1400 / 1400 / 740



Blat okrągły



[D x H]
Ø 1000 / 740

[D x H]
Ø 1200 / 740

[D x H]
Ø 1400 / 740



STOŁY OKOLICZNOŚCIOWE wysokość 1100 mm (noga A)

Blat prostokątny z narożnikami prostymi

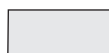

[W x D x H]
1800 / 1000 / 1100
1800 / 1200 / 1100
1800 / 1400 / 1100

[W x D x H]
2000 / 1000 / 1100
2000 / 1200 / 1100
2000 / 1400 / 1100

[W x D x H]
2200 / 1000 / 1100
2200 / 1200 / 1100
2200 / 1400 / 1100

[W x D x H]
2400 / 1000 / 1100
2400 / 1200 / 1100
2400 / 1400 / 1100

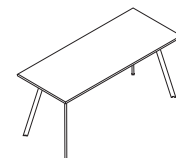

Blat kwadratowy z narożnikami prostymi



[W x D x H]
1000 / 1000 / 1100

[W x D x H]
1200 / 1200 / 1100

[W x D x H]
1400 / 1400 / 1100

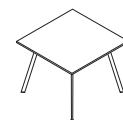

STOŁY OKOLICZNOŚCIOWE wysokość 500 mm (noga A)

Blat prostokątny z narożnikami prostymi



[W x D x H]
1200 / 800 / 500

[W x D x H]
1400 / 800 / 500

[W x D x H]
1600 / 800 / 500



Blat kwadratowy z narożnikami prostymi



[W x D x H]
1000 / 1000 / 500

[W x D x H]
1200 / 1200 / 500

[W x D x H]
1400 / 1400 / 500



Blat okrągły



[D x H]
Ø 1000 / 500

[D x H]
Ø 1200 / 500

[D x H]
Ø 1400 / 500



AXY - LINE

MIEJSCA MONTAŻU MEDIAPORTU

BLAT JEDNOELEMENTOWY

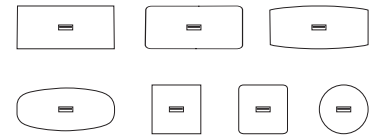
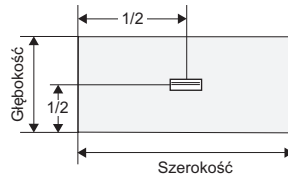

Mediaport umieszczony w 1/2 głębokości i szerokości blatu jednoelementowego.

BLAT WIELOELEMENTOWY

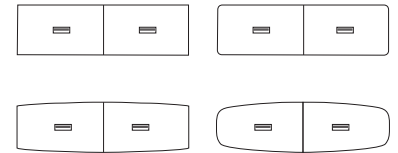
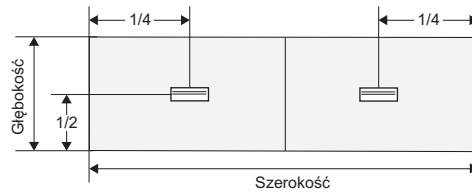
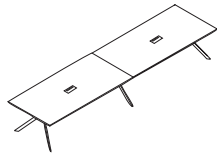

Mediaport umieszczony w 1/2 głębokości i 1/4 szerokości blatu wieloelementowego.

STELAŻ

1. **Noga systemowa A** - profil 20x60 mm, metal malowany proszkowo, noga systemowa spawana od wewnątrz. **Trawersy** - profil 45x45 mm, metal malowany proszkowo.

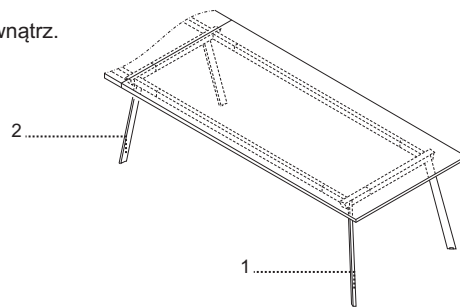

1. Noga początkowa A

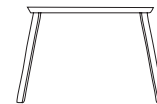

Widok z przodu

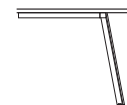

Widok z boku

2. Noga wewnętrzna A

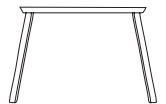

Widok z przodu

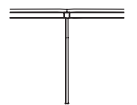

Widok z boku

2. **Noga systemowa X** - profil 20x60 mm, metal malowany proszkowo, noga systemowa spawana od wewnątrz. **Trawersy** - profil 45x45 mm, metal malowany proszkowo.

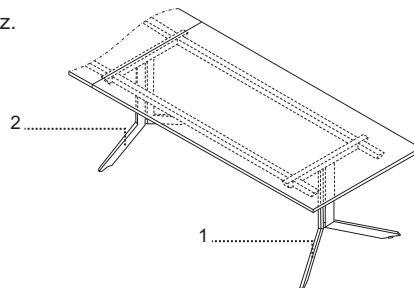

1. Noga początkowa X

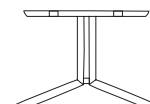

Widok z przodu

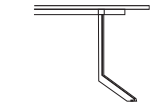

Widok z boku

2. Noga wewnętrzna X

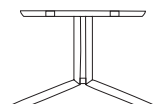

Widok z przodu

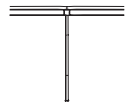

Widok z boku

3. **Noga systemowa Y** - profil 20x60 mm, metal malowany proszkowo, noga systemowa spawana od wewnątrz. **Trawersy** - profil 45x45 mm, metal malowany proszkowo.

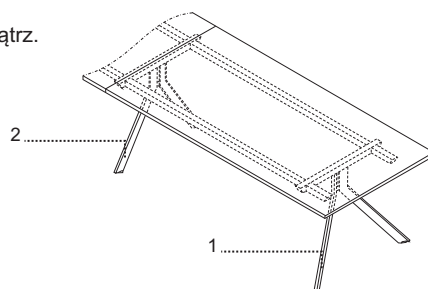

1. Noga początkowa Y



Widok z przodu

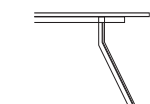

Widok z boku

2. Noga wewnętrzna Y

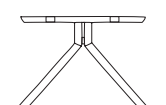

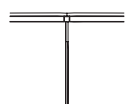

Widok z przodu

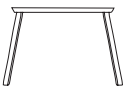

Widok z boku

AXY - LINE

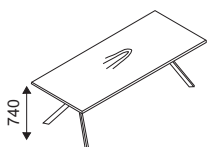
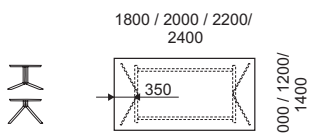
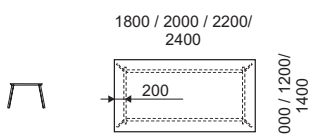
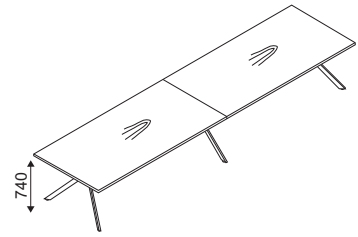
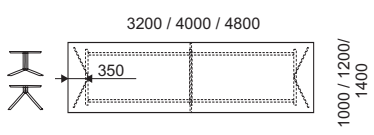
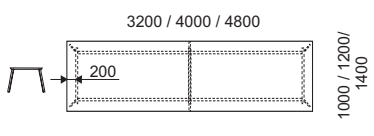
				Noga A		Noga X		Noga Y	
									
Stoły konferencyjne	WYMIARY			Kod	Kod	Kod	Kod	Kod	Kod
	SZ. mm	Gł. mm	WYS. mm						
1. Stoły z blatem prostokątnym z narożnikami prostymi									
  	1800	1000	740	MAA 181074	MAX 181074	MAY 181074			
	1800	1200	740	MAA 181274	MAX 181274	MAY 181274			
	1800	1400	740	MAA 181474	MAX 181474	MAY 181474			
	2000	1000	740	MAA 201074	MAX 201074	MAY 201074			
	2000	1200	740	MAA 201274	MAX 201274	MAY 201274			
	2000	1400	740	MAA 201474	MAX 201474	MAY 201474			
	2200	1000	740	MAA 221074	MAX 221074	MAY 221074			
	2200	1200	740	MAA 221274	MAX 221274	MAY 221274			
	2200	1400	740	MAA 221474	MAX 221474	MAY 221474			
	2400	1000	740	MAA 241074	MAX 241074	MAY 241074			
	2400	1200	740	MAA 241274	MAX 241274	MAY 241274			
	2400	1400	740	MAA 241474	MAX 241474	MAY 241474			
  	3200	1000	740	MAA 321074	MAX 321074	MAY 321074			
	3200	1200	740	MAA 321274	MAX 321274	MAY 321274			
	3200	1400	740	MAA 321474	MAX 321474	MAY 321474			
	4000	1000	740	MAA 401074	MAX 401074	MAY 401074			
	4000	1200	740	MAA 401274	MAX 401274	MAY 401274			
	4000	1400	740	MAA 401474	MAX 401474	MAY 401474			
	4800	1000	740	MAA 481074	MAX 481074	MAY 481074			
	4800	1200	740	MAA 481274	MAX 481274	MAY 481274			
	4800	1400	740	MAA 481474	MAX 481474	MAY 481474			



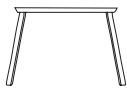
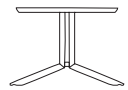
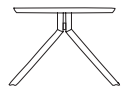
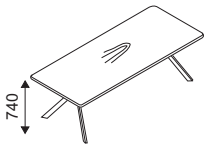
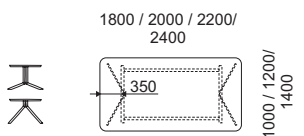
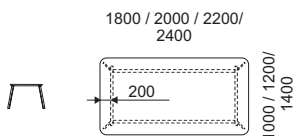
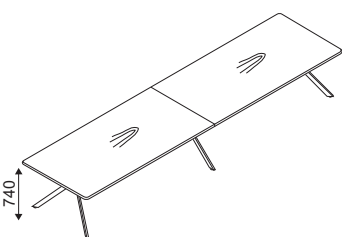
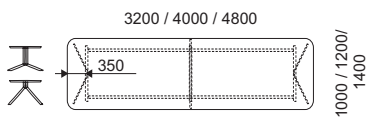
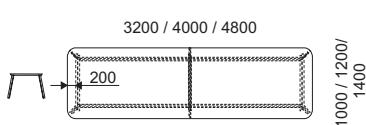

AXY - LINE

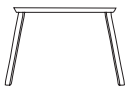
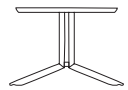
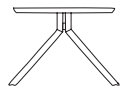
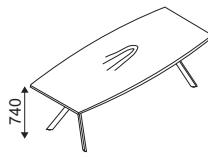
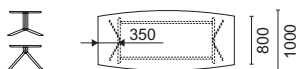
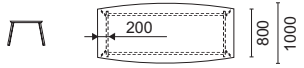
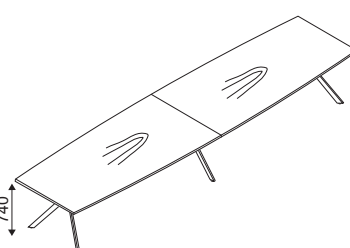
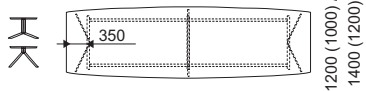
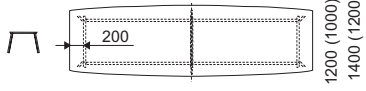
				Noga A		Noga X		Noga Y	
									
Stoły konferencyjne	WYMIARY			Kod	Kod	Kod	Kod	Kod	Kod
	SZ. mm	Gł. mm	WYS. mm						
2. Stoły z blatem prostokątnym z narożnikami zaokrąglonymi      	1800	1000	740	MBA 181074	MBX 181074	MBY 181074			
	1800	1200	740	MBA 181274	MBX 181274	MBY 181274			
	1800	1400	740	MBA 181474	MBX 181474	MBY 181474			
	2000	1000	740	MBA 201074	MBX 201074	MBY 201074			
	2000	1200	740	MBA 201274	MBX 201274	MBY 201274			
	2000	1400	740	MBA 201474	MBX 201474	MBY 201474			
	2200	1000	740	MBA 221074	MBX 221074	MBY 221074			
	2200	1200	740	MBA 221274	MBX 221274	MBY 221274			
	2200	1400	740	MBA 221474	MBX 221474	MBY 221474			
	2400	1000	740	MBA 241074	MBX 241074	MBY 241074			
	2400	1200	740	MBA 241274	MBX 241274	MBY 241274			
	2400	1400	740	MBA 241474	MBX 241474	MBY 241474			
	3200	1000	740	MBA 321074	MBX 321074	MBY 321074			
	3200	1200	740	MBA 321274	MBX 321274	MBY 321274			
	3200	1400	740	MBA 321474	MBX 321474	MBY 321474			
	4000	1000	740	MBA 401074	MBX 401074	MBY 401074			
	4000	1200	740	MBA 401274	MBX 401274	MBY 401274			
	4000	1400	740	MBA 401474	MBX 401474	MBY 401474			
	4800	1000	740	MBA 481074	MBX 481074	MBY 481074			
	4800	1200	740	MBA 481274	MBX 481274	MBY 481274			
4800	1400	740	MBA 481474	MBX 481474	MBY 481474				

AXY - LINE

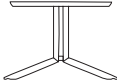
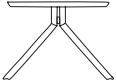
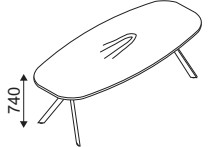
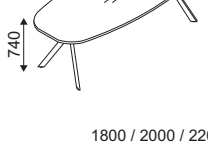
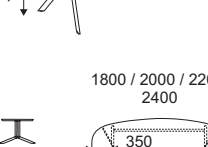
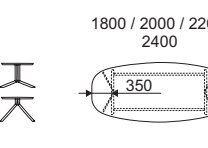
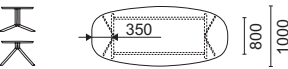
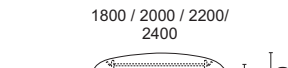
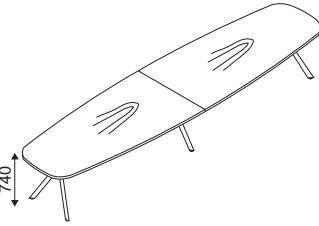
				Noga A		Noga X		Noga Y	
									
Stoły konferencyjne	WYMIARY			Kod	Kod	Kod	Kod	Kod	Kod
	SZ. mm	Gł. mm	WYS. mm						
3. Stoły z blatem kształtowym									
									
1800 / 2000 / 2200 / 2400									
									
1800 / 2000 / 2200 / 2400									
									
3200 / 4000 / 4800									
									
3200 / 4000 / 4800									
									
3200 / 4000 / 4800									
									
1800	1000	740	MCA 181074	MCX 181074	MCY 181074				
2000	1000	740	MCA 201074	MCX 201074	MCY 201074				
2200	1000	740	MCA 221074	MCX 221074	MCY 221074				
2400	1000	740	MCA 241074	MCX 241074	MCY 241074				
3200	1200	740	MCA 321274	MCX 321274	MCY 321274				
3200	1400	740	MCA 321474	MCX 321474	MCY 321474				
4000	1200	740	MCA 401274	MCX 401274	MCY 401274				
4000	1400	740	MCA 401474	MCX 401474	MCY 401474				
4800	1200	740	MCA 481274	MCX 481274	MCY 481274				
4800	1400	740	MCA 481474	MCX 481474	MCY 481474				

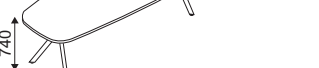
AXY - LINE

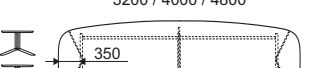
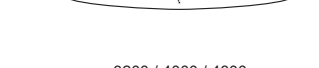
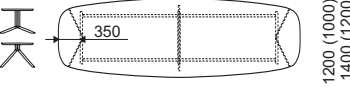
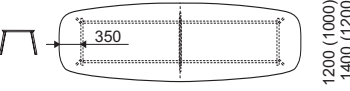
				Noga A		Noga X		Noga Y	
									
Stoły konferencyjne	WYMIARY			Kod	Kod	Kod	Kod	Kod	Kod
	SZ. mm	Gł. mm	WYS. mm						
4. Stoły z blatem owalnym									
	1800	1000	740	MDA 181074		MDX 181074		MDY 181074	
	2000	1000	740	MDA 201074		MDX 201074		MDY 201074	
	2200	1000	740	MDA 221074		MDX 221074		MDY 221074	
	2400	1000	740	MDA 241074		MDX 241074		MDY 241074	
	1800 / 2000 / 2200 / 2400								
	1800 / 2000 / 2200 / 2400								
	3200	1200	740	MDA 321274		MDX 321274		MDY 321274	
	3200	1400	740	MDA 321474		MDX 321474		MDY 321474	
	4000	1200	740	MDA 401274		MDX 401274		MDY 401274	
	4000	1400	740	MDA 401474		MDX 401474		MDY 401474	
	4800	1200	740	MDA 481274		MDX 481274		MDY 481274	
	4800	1400	740	MDA 481474		MDX 481474		MDY 481474	
	3200 / 4000 / 4800								
	3200 / 4000 / 4800								



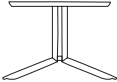
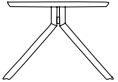
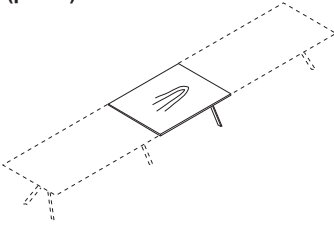
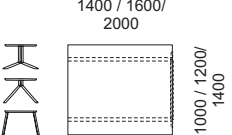
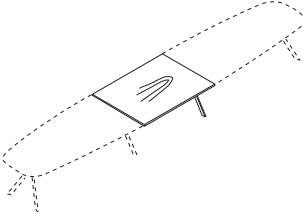
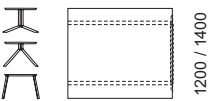

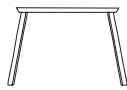
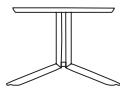
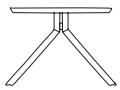
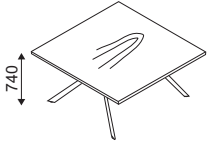
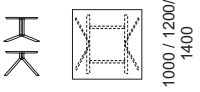
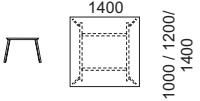
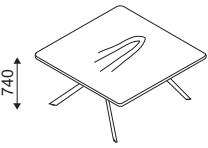
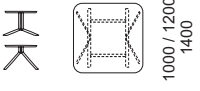
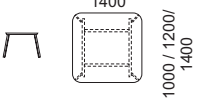
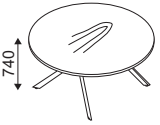
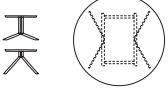
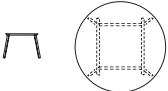

AXY - LINE

				Noga A		Noga X		Noga Y	
									
Moduły wydłużające do stołów konferencyjnych	WYMIARY			Kod	Kod	Kod	Kod	Kod	Kod
	SZ. mm	Gł. mm	WYS. mm						
5. Moduł wydłużający do stołów z blatem prostokątnym z narożnikami prostymi (pkt. 1) oraz z blatem prostokątnym z narożnikami zaokrąglonymi (pkt. 2)  	1400	1000	740	MPA 141074	MPX 141074	MPY 141074			
	1400	1200	740	MPA 141274	MPX 141274	MPY 141274			
	1400	1400	740	MPA 141474	MPX 141474	MPY 141474			
	1600	1000	740	MPA 161074	MPX 161074	MPY 161074			
	1600	1200	740	MPA 161274	MPX 161274	MPY 161274			
	1600	1400	740	MPA 161474	MPX 161474	MPY 161474			
	2000	1000	740	MPA 201074	MPX 201074	MPY 201074			
	2000	1200	740	MPA 201274	MPX 201274	MPY 201274			
	2000	1400	740	MPA 201474	MPX 201474	MPY 201474			
	6. Moduł wydłużający do stołów z blatem kształtowym (pkt. 3) oraz z blatem owalnym (pkt. 4)  	1400	1200	740	MNA 141274	MNX 141274	MNY 141274		
1400		1400	740	MNA 141474	MNX 141474	MNY 141474			
1600		1200	740	MNA 161274	MNX 161274	MNY 161274			
1600		1400	740	MNA 161474	MNX 161474	MNY 161474			
2000		1200	740	MNA 201274	MNX 201274	MNY 201274			
2000		1400	740	MNA 201474	MNX 201474	MNY 201474			

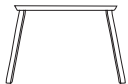
AXY - LINE

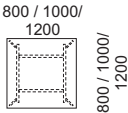
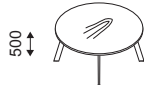
				Noga A		Noga X		Noga Y	
									
Stoły okolicznościowe H = 740 mm	WYMIARY			Kod	Kod	Kod	Kod	Kod	Kod
	SZ. mm	Gł. mm	WYS. mm						
1. Stoły z blatem kwadratowym									
	1000	1000	740	MAA 101074		MAX 101074		MAY 101074	
1000 / 1200 / 1400 	1200	1200	740	MAA 121274		MAX 121274		MAY 121274	
1000 / 1200 / 1400 	1400	1400	740	MAA 141474		MAX 141474		MAY 141474	
2. Stoły z blatem kwadratowym i zaokrąglonymi narożnikami									
	1000	1000	740	MBA 101074		MBX 101074		MBY 101074	
1000 / 1200 / 1400 	1200	1200	740	MBA 121274		MBX 121274		MBY 121274	
1000 / 1200 / 1400 	1400	1400	740	MBA 141474		MBX 141474		MBY 141474	
3. Stoły z blatem okrągłym									
	1000	1000	740	MOA 101074		MOX 101074		MOY 101074	
∅1000 / 1200 / 1400 	1200	1200	740	MOA 121274		MOX 121274		MOY 121274	
∅1000 / 1200 / 1400 	1400	1400	740	MOA 141474		MOX 141474		MOY 141474	

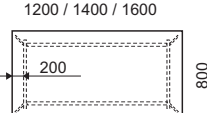
AXY - LINE

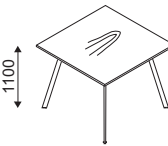
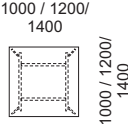
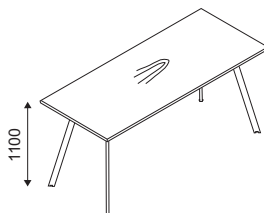
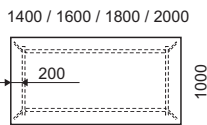
				Noga A			
							
Stoły okolicznościowe niskie H = 500 mm				WYMIARY			Kod
				SZ. mm	GL. mm	WYS. mm	
1. Stoły z blatem kwadratowym				800	800	500	MAA 080850
 				1000	1000	500	MAA 101050
				1200	1200	500	MAA 121250
2. Stoły z blatem okrągłym				800	800	500	MOA 080850
 				1000	1000	500	MOA 101050
				1200	1200	500	MOA 121250
3. Stoły z blatem prostokątnym				1200	800	500	MAA 120850
 				1400	800	500	MAA 140850
				1600	800	500	MAA 160850
				Noga A			
							
Stoły okolicznościowe wysokie H = 1100 mm				WYMIARY			Kod
				SZ. mm	GL. mm	WYS. mm	
1. Stoły z blatem kwadratowym				1000	1000	1100	MAA 101011
 				1200	1200	1100	MAA 121211
				1400	1400	1100	MAA 141411
2. Stoły z blatem prostokątnym				1400	1000	1100	MAA 141011
 				1600	1000	1100	MAA 161011
				1600	1200	1100	MAA 161211
				1800	1000	1100	MAA 181011
				1800	1200	1100	MAA 181211
				2000	1000	1100	MAA 201011
				2000	1200	1100	MAA 201211

NOTATKI